



2024



# ACTUADORES ELÉCTRICOS

Selección completa de actuadores eléctricos, disponible en ATEX con posicionador, bloque de cierre por seguridad y contactos auxiliares.

- Grado de protección IP68
- Hasta 2400Nm
- Sistema anti condensación
- Posibilidad de conexión mediante BLUETOOTH
- Posicionador
- FAIL SAFE
- ATEX



## ELECTRIC ACTUATORS

A complete selection of actuators, available in ATEX with positioner, safety closing block and auxiliary contacts.

- Enclosure: IP68
- Up to 2400Nm
- Anti condensation system
- Possibility of connection through BLUETOOTH
- Positioner
- FAIL SAFE
- ATEX

**VS**

- Carcasa de aluminio y poliamida PA6 ULV-O.
- Tapa de aluminio opcional.
- Accionamiento manual mediante volante.
- Para pares de 100 a 300 Nm,
- Directiva CE-ROHS-REACH

**VS**

- Aluminium and polyamide PA6 UL 94 V-O housing.
- Aluminium (option) cover.
- Manual override by wheel.
- For torques from 100 to 300Nm.
- CE-ROHS-REACH Directive

**VT PLUS**

- Carcasa y tapa de aluminio.
- Accionamiento manual mediante volante
- Para pares de 600 a 2400Nm.
- Directiva CE-ROHS-REA CH.

**VT PLUS**

- Aluminium housing and cover.
- Manual override by hand wheel
- For torques from 600 to 2400Nm.
- CE-ROHS-REACH Directives.

**MARINER**

La versión de revestimiento marino es la solución para aplicaciones marinas. Adecuado para atmósferas corrosivas como plataformas marinas, barcos, industrias costeras o marítimas.

**MARINER**

The marine coating version is the solution for marine applications. Suitable for corrosive atmospheres such as offshore platforms, boats, maritime or coastal industries.

# ACTUADORES ELECTRICOS rotatorios 90°

- Sistema de multitensión de 24V a 220V en alterna y continua
- 4 finales de carrera
- Posibilidad de poner una batería en caso de caídas de tensión
- IP-67
- Resistencia calefactora 3,5 W
- Grado protección IEC 60529
- Disponemos de posicionadores y más opciones



-20°C ~+70°C  
-4F ~ +158°F



4 SPST-NO



EN175301-803 FORM A  
DIN 43650/C



Poliamida  
Polyamide



## ELECTRIC ACTUATORS 90° rotary

- Multivoltage system from 24V to 220V in AC and DC
- 4 limit switch
- Option: Emergency fail self kit system by battery
- IP-67
- Automatic heater 3.5 W
- Protection IEC 60529 rating
- We have positioners and many more options

### ACTUADOR MONOFÁSICO

### SINGLE-PHASE ACTUATOR

MOD.	Tiempo maniobra sin carga Operational time unload	Par máximo arranque Maximum torque break	Par máximo operacional Max. Operational torque	Peso Weight
CS20	10 seg / 90°	25 Nm 221 lb/in	20 Nm 177 lb/in	1.8 kg
CS35	10 seg / 90°	38 Nm 359,3 lb/in	35 Nm 309 lb/in	1.9 kg
CS66	14 seg / 90°	60 Nm 530 lb/in	55 Nm 486 lb/in	2.4 kg
CS85	30 seg / 90°	90 Nm 796.3 lb/in	85 Nm 752 lb/in	3 kg

## 1121W CS

Pag. 13

### VÁLVULAS DE BOLA 2 PIEZAS

### BALL VALVES 2 PIECES

ROSCA GAS · BSP

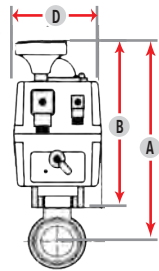
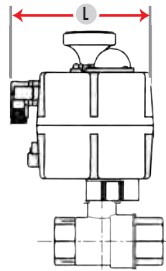

Válvula	Actuador	L	D	B	A
1121W 008	CS20	181	110	169	199
1121W 010	CS20	181	110	169	199
1121W 015	CS20	181	110	169	233
1121W 020	CS20	181	110	169	236
1121W 025	CS20	181	110	169	245
1121W 032	CS35	181	110	169	249
1121W 040	CS35	181	110	169	258
1121W 050	CS55	181	110	196	266
1121W 065	CS85	181	110	196	291
1121W 080	CS140	235	214	254	364

## 1531W CS

Pag. 14

### VÁLVULAS DE BOLA 3 PIEZAS

### BALL VALVES 3 PIECES

BSP · NPT

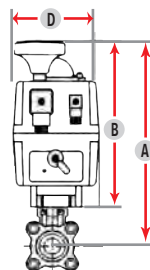
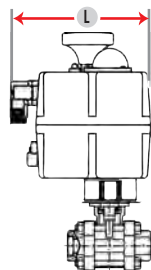

Válvula	Actuador	L	D	B	A
1531W 008	CS20	181	110	169	200
1531W 010	CS20	181	110	169	200
1531W 015	CS20	181	110	169	209
1531W 020	CS20	181	110	169	215
1531W 025	CS20	181	110	169	226
1531W 032	CS35	181	110	169	233
1531W 040	CS35	181	110	169	240
1531W 050	CS55	181	110	196	278
1531W 065	CS85	181	110	196	294
1531W 080	CS140	235	214	254	364
1531W 100	CS300	235	214	254	384

## 1533W CS

Pag. 14

### VÁLVULAS DE BOLA 3 PIEZAS

### BALL VALVES 3 PIECES

BUTT WELD

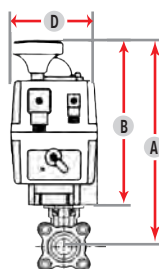
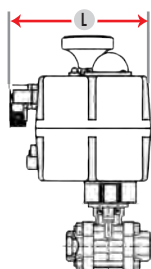

Válvula	Actuador	L	D	B	A
1533W 008	CS20	181	110	169	200
1533W 010	CS20	181	110	169	200
1533W 015	CS20	181	110	169	209
1533W 020	CS20	181	110	169	215
1533W 025	CS20	181	110	169	226
1533W 032	CS35	181	110	169	233
1533W 040	CS35	181	110	169	240
1533W 050	CS55	181	110	196	278
1533W 065	CS85	181	110	196	294
1533W 080	CS140	235	214	254	364
1533W 100	CS300	235	214	254	384

VÁLVULAS MANUALES  
MANUAL VALVES

ACTUADORES NEUMÁTICOS  
PNEUMATIC ACTUATORS

ACTUADORES ELÉCTRICOS  
ELECTRIC ACTUATORS

ELECTROVÁLVULAS HAFNER  
HAFNER SOLENOID VALVES

ACCESORIOS  
ACCESSORIES

# 1534W CS

Pag. 15

## VÁLVULAS DE BOLA 3 PIEZAS

## BALL VALVES 3 PIECES

### SOCKET WELD

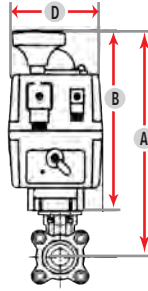
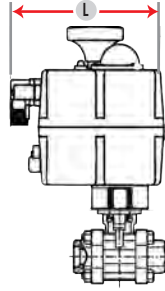

Válvula	Actuador	L	D	B	A
1534W 008	CS20	181	110	169	200
1534W 010	CS20	181	110	169	200
1534W 015	CS20	181	110	169	209
1534W 020	CS20	181	110	169	215
1534W 025	CS20	181	110	169	226
1534W 032	CS20	181	110	169	233
1534W 040	CS35	181	110	169	240
1534W 050	CS35	181	110	169	278
1534W 065	CS55	181	110	196	294
1534W 080	CS140	235	214	254	364
1534W 100	CS300	235	214	254	384

# 1535W CS

Pag. 15

## VÁLVULAS DE BOLA 3 PIEZAS

## BALL VALVES 3 PIECES

### CLAMP

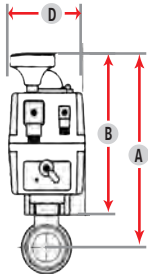
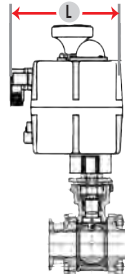

Válvula	Actuador	L	D	B	A
1535W 008	CS20	181	110	169	200
1535W 010	CS20	181	110	169	200
1535W 015	CS20	181	110	169	209
1535W 020	CS20	181	110	169	215
1535W 025	CS20	181	110	169	226
1535W 032	CS35	181	110	169	233
1535W 040	CS35	181	110	169	240
1535W 050	CS55	181	110	196	278
1535W 065	CS85	181	110	196	294
1535W 080	CS140	235	214	254	364
1535W 100	CS300	235	214	254	384

# 1571W CS

Pag. 16

## VÁLVULAS DE BOLA 3 VIAS L/T

## BALL VALVES 3 WAY L/T

BSP

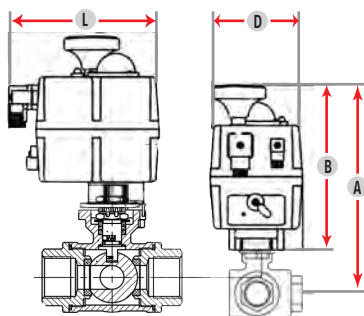

Válvula	Actuador	L	D	B	A
1571W 008	CS20	181	110	169	205
1571W 010	CS20	181	110	169	205
1571W 015	CS20	181	110	169	205
1571W 020	CS20	181	110	169	208
1571W 025	CS20	181	110	169	215,5
1571W 032	CS35	181	110	169	224
1571W 040	CS55	181	110	196	267
1571W 050	CS55	181	110	196	267

# 6021W CS

Pag. 16

## VÁLVULAS DE BOLA PVC

## BALL VALVES PVC

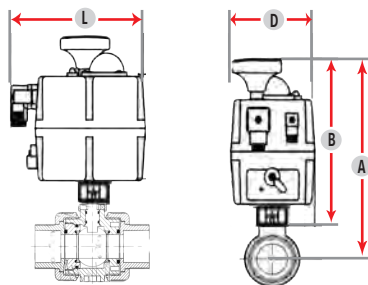

Válvula	Actuador	L	D	B	A
6021W 015	CS20	181	110	169	249
6021W 020	CS20	181	110	169	253
6021W 025	CS20	181	110	169	285
6021W 032	CS20	181	110	169	287
6021W 040	CS20	181	110	169	294
6021W 050	CS20	181	110	169	301
6021W 065	CS55	181	110	196	341
6021W 080	CS85	181	110	196	355
6021W 100	CS85	181	214	196	380

VÁLVULAS MANUALES  
MANUAL VALVES

ACTUADORES NEUMÁTICOS  
PNEUMATIC ACTUATORS

ACTUADORES ELÉCTRICOS  
ELECTRIC ACTUATORS

ELECTROVÁLVULAS HAFNER  
HAFNER SOLENOID VALVES

ACCESORIOS  
ACCESSORIES

3135W CS Pag. 18  
BRIDAS · FLANGES

VÁLVULAS DE BOLA  
2 PIEZAS

BALL VALVES  
2 PIECES

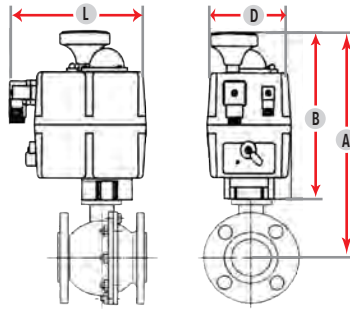

Válvula	Actuador	L	D	B	A
3135W 015	CS20	181	110	169	217,5
3135W 020	CS20	181	110	169	222,5
3135W 025	CS20	181	110	169	228
3135W 032	CS35	181	110	169	240
3135W 040	CS35	181	110	169	246,5
3135W 050	CS55	181	110	196	281
3135W 065	CS85	181	110	196	296
3135W 080	CS140	235	214	254	364
3135W 100	CS300	235	214	254	384

3225W CS Pag. 18  
BRIDAS · FLANGES

VÁLVULAS DE BOLA  
2 PIEZAS

BALL VALVES  
2 PIECES

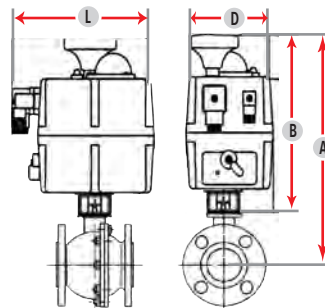

Válvula	Actuador	L	D	B	A
3225W 015	CS20	181	110	169	262,5
3225W 020	CS20	181	110	169	267
3225W 025	CS20	181	110	169	273,5
3225W 032	CS35	181	110	169	286
3225W 040	CS35	181	110	169	291
3225W 050	CS55	181	110	196	326
3225W 065	CS85	181	110	196	354
3225W 080	CS140	235	214	254	422,5
3225W 100	CS140	235	214	254	448
3225W 125	CS300	235	214	254	479
3225W 150	CS300	235	214	254	504

3136W CS Pag. 19  
BRIDAS · FLANGES

VÁLVULAS DE BOLA  
2 PIEZAS

BALL VALVES  
2 PIECES

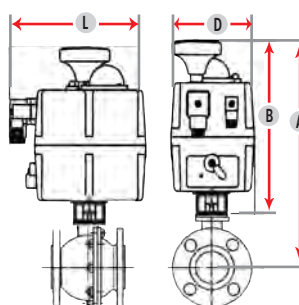

Válvula	Actuador	L	D	B	A
3136W 015	CS20	181	110	169	260
3136W 020	CS20	181	110	169	262
3136W 025	CS20	181	110	169	278
3136W 032	CS35	181	110	169	283
3136W 040	CS35	181	110	169	333
3136W 050	CS85	181	110	196	338
3136W 065	CS85	181	110	196	350
3136W 080	CS140	235	214	254	443
3136W 100	CS140	235	214	254	468
3136W 125	CS300	235	214	254	508
3136W 150	CS300	235	214	254	527



# 3651W CS

Pag. 19

**VÁLVULAS DE BOLA  
3 VIAS L / T**

**BALL VALVES  
3 WAY L / T**

BRIDAS · FLANGES

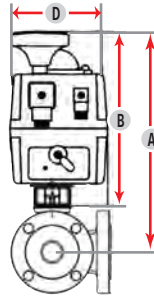
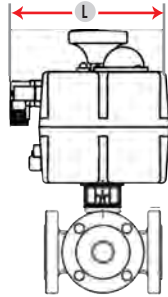

Válvula	Actuador	L	D	B	A
3651W 025	CS35	181	110	196	260
3651W 032	CS55	181	110	196	275
3651W 040	CS85	181	110	196	285
3651W 050	CS140	235	214	254	360
3651W 065	CS300	235	214	254	371
3651W 080	CS300	235	214	254	382

# 3451W CS

Pag. 20

**VÁLVULAS DE BOLA  
3 VIAS L / T**

**BALL VALVES  
3 WAY L / T**

BRIDAS · FLANGES

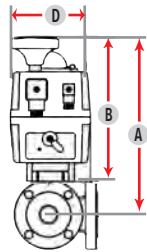
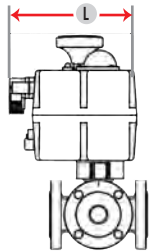

Válvula	Actuador	L	D	B	A
3451W 025	CS35	181	110	196	260
3451W 032	CS55	181	110	196	275
3451W 040	CS85	181	110	196	285
3451W 050	CS140	235	214	254	360
3451W 065	CS300	235	214	254	371
3451W 080	CS300	235	214	254	382

VÁLVULAS MANUALES  
MANUAL VALVES

ACTUADORES NEUMÁTICOS  
PNEUMATIC ACTUATORS

ACTUADORES ELÉCTRICOS  
ELECTRIC ACTUATORS

ELECTROVÁLVULAS HAFNER  
HAFNER SOLENOID VALVES

ACCESORIOS  
ACCESSORIES

## 3634A CS

FUSION · CAST

Pag.  
21

VÁLVULAS DE BOLA  
WAFER

BALL VALVES  
WAFER

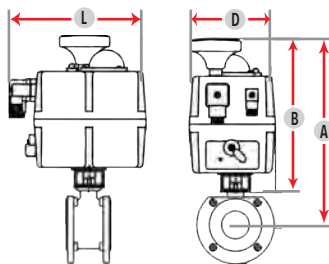

Válvula	Actuador	L	D	B	A
3634A 040	CS55	181	110	196	293,5
3634A 050	CS55	181	110	196	300,5
3634A 065	CS85	181	110	196	343
3634A 080	CS140	235	214	254	411
3634A 100	CS300	235	214	254	422

## 3635A CS

FORJADO · FORGED

Pag.  
21

VÁLVULAS DE BOLA  
WAFER

BALL VALVES  
WAFER

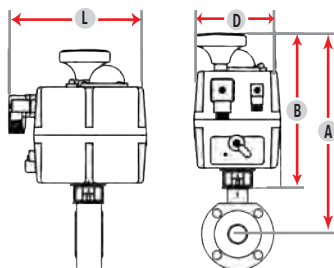

Válvula	Actuador	L	D	B	A
3635A 015	CS20	181	110	169	260
3635A 020	CS20	181	110	169	270
3635A 025	CS20	181	110	169	281
3635A 032	CS35	181	110	169	296

## 3625A CS

Pag.  
22

VÁLVULAS DE BOLA  
WAFER

BALL VALVES  
WAFER

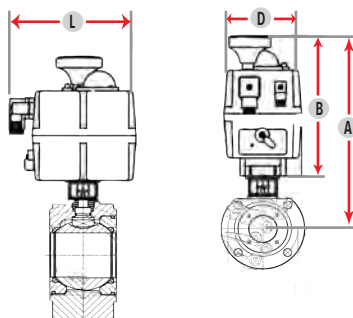

Válvula	Actuador	L	D	B	A
3625A 015	CS20	181	110	169	300
3625A 020	CS20	181	110	169	310
3625A 025	CS20	181	110	169	321
3625A 032	CS35	181	110	169	336
3625A 040	CS55	181	110	196	385,5
3625A 050	CS55	181	110	196	406,5
3625A 065	CS85	181	110	196	430,5
3625A 080	CS140	235	214	254	508,5
3625A 100	CS300	235	214	254	629,5

# 3637A CS

Pag. 23

**VÁLVULAS DE BOLA  
WAFER · Cámara de calefacción**

**BALL VALVES  
WAFER · Heating chamber**

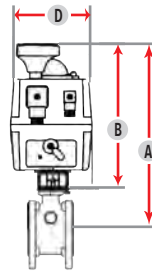
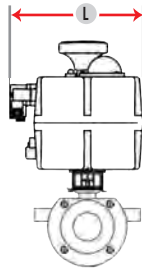

Válvula	Actuador	L	D	B	A
3637A 015	CS20	181	110	169	300
3637A 020	CS20	181	110	169	310
3637A 025	CS20	181	110	169	321
3637A 032	CS35	181	110	169	336
3637A 040	CS55	181	110	196	385,5
3637A 050	CS55	181	110	196	406,5
3637A 065	CS85	181	110	196	430,5
3637A 080	CS140	235	214	254	508,5
3637A 100	CS300	235	214	254	629,5

# 3627A CS

Pag. 23

**VÁLVULAS DE BOLA  
WAFER · Cámara de calefacción**

**BALL VALVES  
WAFER · Heating chamber**

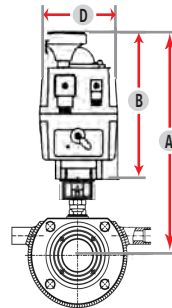
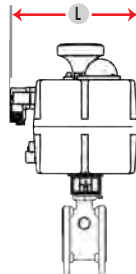

Válvula	Actuador	L	D	B	A
3627A 015	CS20	181	110	169	300
3627A 020	CS20	181	110	169	310
3627A 025	CS20	181	110	169	321
3627A 032	CS35	181	110	169	336
3627A 040	CS55	181	110	196	385,5
3627A 050	CS55	181	110	196	406,5
3627A 065	CS85	181	110	196	430,5
3627A 080	CS140	235	214	254	508,5
3627A 100	CS300	235	214	254	629,5

# 3638A CS

Pag. 24

**VÁLVULAS DE BOLA  
WAFER · Cámara de calefacción**

**BALL VALVES  
WAFER · Heating chamber**

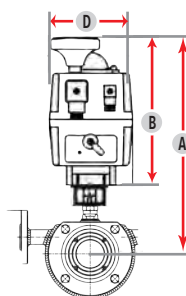
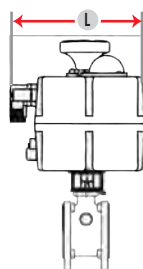

Válvula	Actuador	L	D	B	A
3638A 015	CS20	181	110	169	300
3638A 020	CS20	181	110	169	310
3638A 025	CS20	181	110	169	321
3638A 032	CS35	181	110	169	336
3638A 040	CS55	181	110	196	385,5
3638A 050	CS55	181	110	196	406,5
3638A 065	CS85	181	110	196	430,5
3638A 080	CS140	235	214	254	508,5
3638A 100	CS300	235	214	254	629,5

VÁLVULAS MANUALES  
MANUAL VALVES

ACTUADORES NEUMÁTICOS  
PNEUMATIC ACTUATORS

ACTUADORES ELÉCTRICOS  
ELECTRIC ACTUATORS

ELECTROVÁLVULAS HAFNER  
HAFNER SOLENOID VALVES

ACCESORIOS  
ACCESSORIES

# 3628A CS

Pag. 24

## VÁLVULAS DE BOLA WAFER · Cámara de calefacción

## BALL VALVES WAFER · Heating chamber

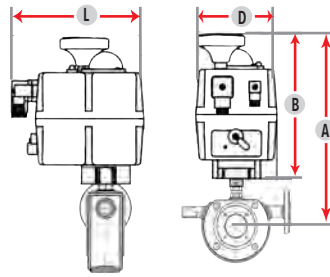

Válvula	Actuador	L	D	B	A
3628A 015	CS20	181	110	169	300
3628A 020	CS20	181	110	169	310
3628A 025	CS20	181	110	169	321
3628A 032	CS35	181	110	169	336
3628A 040	CS55	181	110	196	385,5
3628A 050	CS55	181	110	196	406,5
3628A 065	CS85	181	110	196	430,5
3628A 080	CS140	235	214	254	508,5
3628A 100	CS300	235	214	254	629,5



2131 CS  
BSP

Pag.  
27

VÁLVULAS DE BOLA  
LATÓN

BALL VALVES  
BRASS

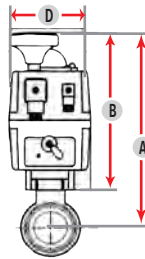
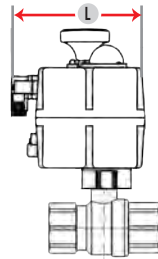

Válvula	Actuador	L	D	B	A
2131 015	CS20	181	110	169	198,4
2131 020	CS20	181	110	169	202
2131 025	CS20	181	110	169	206,2
2131 032	CS20	181	110	169	216,5
2131 040	CS20	181	110	169	222
2131 050	CS35	181	110	169	233
2131 065	CS55	181	110	196	278,5
2131 080	CS55	181	110	196	290,5

2051E CS  
2052E CS  
LATÓN · BRASS

Pag.  
27

VÁLVULAS DE BOLA  
3 VIAS L / T

BALL VALVES  
3 WAY L / T

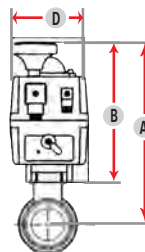
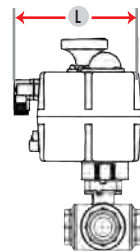

Válvula	Actuador	L	D	B	A
2051E 008	CS20	181	110	169	207
2051E 010	CS20	181	110	169	207
2051E 015	CS20	181	110	169	207
2051E 020	CS20	181	110	169	211
2051E 025	CS35	181	110	169	215,5
2051E 032	CS35	181	110	169	230
2051E 040	CS35	181	110	169	232,5
2051E 050	CS35	181	110	169	243

VÁLVULAS MANUALES  
MANUAL VALVES

ACTUADORES NEUMÁTICOS  
PNEUMATIC ACTUATORS

ACTUADORES ELÉCTRICOS  
ELECTRIC ACTUATORS

ELECTROVÁLVULAS HAFNER  
HAFNER SOLENOID VALVES

ACCESORIOS  
ACCESSORIES

# 4254 CS

Pag.  
28

VÁLVULAS DE BOLA  
ALTA PRESIÓN

BALL VALVES  
HIGH PRESSURE

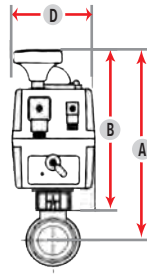
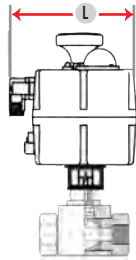

Válvula	Actuador	L	D	B	A
4254 010	CS20	181	110	169	240,5
4254 015	CS20	181	110	169	239,85
4254 020	CS35	181	110	169	255,1
4254 025	CS55	181	110	196	286
4254 032	CS85	181	110	196	292,5
4254 040	CS140	235	214	254	357,5
4254 050	CS300	235	214	254	361

# 4256 CS

Pag.  
28

VÁLVULAS DE BOLA  
ALTA PRESIÓN

BALL VALVES  
HIGH PRESSURE

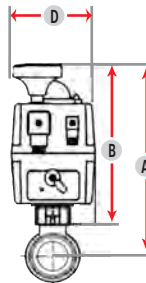
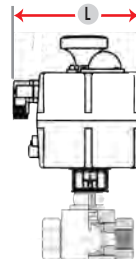

Válvula	Actuador	L	D	B	A
4256 010	CS20	181	110	169	240,5
4256 015	CS20	181	110	169	239,85
4256 020	CS35	181	110	169	255,1
4256 025	CS55	181	110	196	286
4256 032	CS85	181	110	196	292,5
4256 040	CS140	235	214	254	357,5
4256 050	CS300	235	214	254	361

## 7205W CS

Pag. 30

### VÁLVULAS DE MARIPOSA WAFFER

### BUTTERFLY VALVES WAFFER

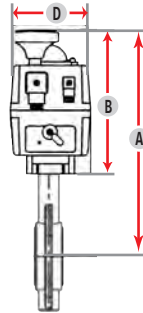
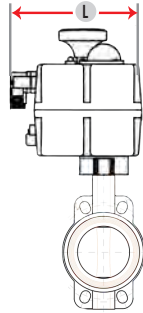

Válvula	Actuador	L	D	B	A
7205W 040	CS20	181	110	169	308
7205W 050	CS20	181	110	169	323
7205W 065	CS35	181	110	169	329
7205W 080	CS55	181	110	196	339
7205W 100	CS55	181	110	196	356
7205W 125	CS85	181	110	196	374
7205W 150	CS140	235	214	254	471
7205W 200	CS300	235	214	254	511

## 7205L CS

Pag. 30

### VÁLVULAS DE MARIPOSA LUG

### BUTTERFLY VALVES LUG

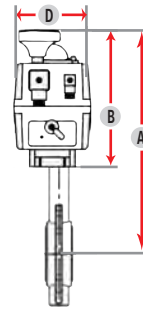
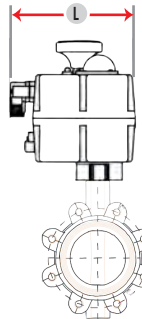

Válvula	Actuador	L	D	B	A
7205L 040	CS20	181	110	169	308
7205L 050	CS20	181	110	169	323
7205L 065	CS35	181	110	169	329
7205L 080	CS55	181	110	196	339
7205L 100	CS55	181	110	196	356
7205L 125	CS85	181	110	196	374
7205L 150	CS140	235	214	254	471
7205L 200	CS300	235	214	254	511

## 7505W CS

Pag. 31

### VÁLVULAS DE MARIPOSA WAFFER

### BUTTERFLY VALVES WAFFER

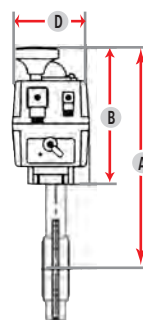
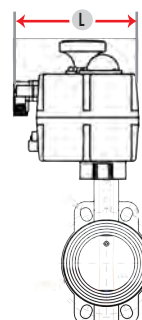

Válvula	Actuador	L	D	B	A
7205W 040	CS20	181	110	169	308
7205W 050	CS20	181	110	169	323
7205W 065	CS20	181	110	169	329
7205W 080	CS35	181	110	169	339
7205W 100	CS35	181	110	169	356
7205W 125	CS55	181	110	196	374
7205W 150	CS55	181	110	196	471
7205W 200	CS140	181	110	254	511

VÁLVULAS MANUALES  
MANUAL VALVES

ACTUADORES NEUMÁTICOS  
PNEUMATIC ACTUATORS

ACTUADORES ELÉCTRICOS  
ELECTRIC ACTUATORS

ELECTROVÁLVULAS HAFNER  
HAFNER SOLENOID VALVES

ACCESORIOS  
ACCESSORIES

# 7211W CS Pag. 31

## VÁLVULAS DE MARIPOSA WAFER

## BUTTERFLY VALVES WAFER

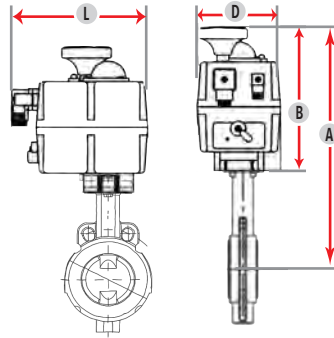

Válvula	Actuador	L	D	B	A
7211W 050	CS35	181	110	169	323
7211W 065	CS85	181	110	196	329
7211W 080	CS140	235	214	254	422
7211W 100	CS300	235	214	254	442
7211W 125	CS300	235	214	254	460
7211W 150	CS300	235	214	254	469
7211W 200	CS300	235	214	254	508

# 6071W CS Pag. 32

## VÁLVULAS DE MARIPOSA PVC

## BUTTERFLY VALVES PVC

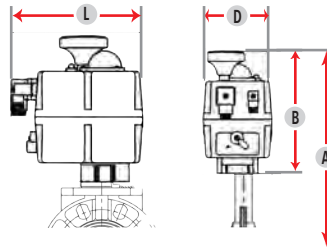

Válvula	Actuador	L	D	B	A
6071W 050	CS20	181	110	169	272
6071W 065	CS20	181	110	169	283
6071W 080	CS20	181	110	169	289
6071W 100	CS35	181	110	169	303
6071W 125	CS55	181	110	196	349
6071W 150	CS85	181	110	196	364
6071W 200	CS140	181	110	254	400



# 4123 CS

Pag. 33

## VÁLVULAS MARIPOSA SANITARIA SOLDAR

## SANITARY BUTTERFLY VALVES BUTT WELD

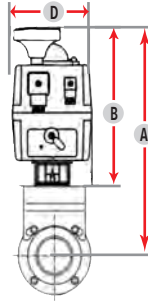
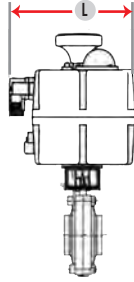

Válvula	Actuador	L	D	B	A
4123 025	CS20	181	110	169	252,5
4123 040	CS20	181	110	169	267,5
4123 050	CS20	181	110	169	274
4123 065	CS20	181	110	169	282,5
4123 080	CS35	181	110	169	290
4123 100	CS55	181	110	196	327

# 4125 CS

Pag. 33

## VÁLVULAS MARIPOSA SANITARIA CLAMP

## SANITARY BUTTERFLY VALVES CLAMP

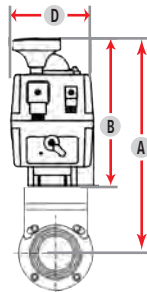
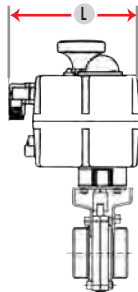

Válvula	Actuador	L	D	B	A
4125 025	CS20	181	110	169	252,5
4125 040	CS20	181	110	169	267,5
4125 050	CS20	181	110	169	274
4125 065	CS20	181	110	169	282,5
4125 080	CS35	181	110	169	290
4125 100	CS55	181	110	196	327

# 4127 CS

Pag. 34

## VÁLVULAS MARIPOSA SANITARIA ROSCA

## SANITARY BUTTERFLY VALVES THREAD

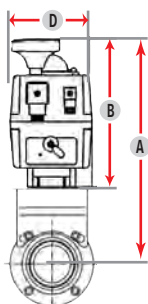
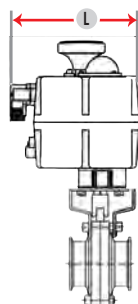

Válvula	Actuador	L	D	B	A
4127 025	CS20	181	110	169	252,5
4127 040	CS20	181	110	169	267,5
4127 050	CS20	181	110	169	274
4127 065	CS20	181	110	169	282,5
4127 080	CS35	181	110	169	290
4127 100	CS55	181	110	196	327

VÁLVULAS MANUALES  
MANUAL VALVES

ACTUADORES NEUMÁTICOS  
PNEUMATIC ACTUATORS

ACTUADORES ELÉCTRICOS  
ELECTRIC ACTUATORS

ELECTROVÁLVULAS HAFNER  
HAFNER SOLENOID VALVES

ACCESORIOS  
ACCESSORIES

# 4129 CS

Pag. 34

## VÁLVULAS MARIPOSA SANITARIA ROSCA - TUERCA

## SANITARY BUTTERFLY VALVES THREAD - NUT

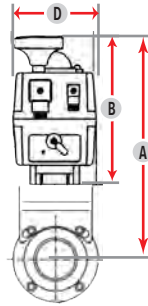
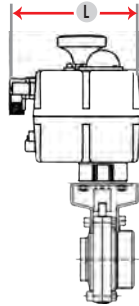

Válvula	Actuador	L	D	B	A
4129 025	CS20	181	110	169	252,5
4129 040	CS20	181	110	169	267,5
4129 050	CS20	181	110	169	274
4129 065	CS20	181	110	169	282,5
4129 080	CS35	181	110	169	290
4129 100	CS55	181	110	196	327

